



MAXXY GROUP

ONE GUYANA

ONE GUYANA



MAXXY GROUP
ONE GUYANA

ABOUT US

MAXXY GROUP INC is a company that offers its clients the supply of products, services, and development of engineering projects. We are known for providing comprehensive support to the industry in solving, monitoring, and controlling problems, as well as in the continuous improvement of the normal development of its activities. We address the needs and demands of our clients with quality, in a safe and profitable manner, with environmental responsibility and excellent service delivery.

MAXXY GROUP



ONE GUYANA



MAXXY GROUP
ONE GUYANA

ABOUT US

MAXXY GROUP INC Is an Engineering, Procurement, and Construction firm. The Founding Partners have Extensive Experience in the Oil and Gas, Power Generation, Petrochemical, Industrial Plants, and Infrastructure Sectors. We are specialized in the Following Disciplines: Electrical, Piping, Civil, Instrumentation, Commissioning, Plant Start-Up, Maintenance, Conceptual Design Engineering, Detailed Engineering, and Basic Engineering.

MAXXY GROUP



ONE GUYANA



MAXXY GROUP
ONE GUYANA

Our Vision

In the new year, we will expand our market share in the domestic market and begin efforts to enter international markets with a profitable and sustainable portfolio of products and services.

To Be leading EPC (Engineering, procurement and Construction Company in Guyana and the world at Large.

Our Mission

Providing world class quality projects, innovative solutions and create superior value for our clients and stake holders. To satisfy the requirements of our customers and stakeholders by delivering products and services that meet their expectations, ensuring a safe work environment, respecting the environment, and generating profitability.

CORPORATE STRATEGY



Our corporate strategy is focused on service excellence, continuous growth, sustainable development, and the quality of our products and services. We differentiate ourselves with an efficient and productive team that drives us forward every day and guarantees our customers optimal quality and timely delivery, respecting our environment and contributing to the sustainable development of the region

..Our value proposition is aimed at providing excellence in our portfolio of products and services

At *MAXXY GROUP INC*, our compliance is based on the Comprehensive Management System. We are committed to all processes, thus contributing to the focus of our mission and vision, satisfying and exceeding the needs and expectations of our customers.





MAXXY GROUP
ONE GUYANA

STRATEGIC ALLIANCE



COLOMBIA



COLOMBIA



COLOMBIA



ISLA OF ARUBA



MEXICO



ISLA OF CURACAO

ONE GUYANA

ENGINEERING & DESIGN



MAXXY GROUP
ONE GUYANA

At **MAXXY GROUP INC**, we design and execute engineering analyses using technological tools such as AutoCAD and Autodesk Navisworks, constantly solving engineering problems and improving the user experience.



MAXXY GROUP

ONE GUYANA

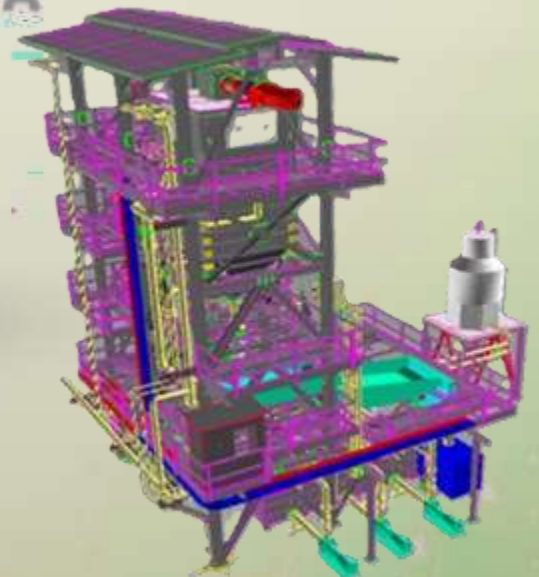
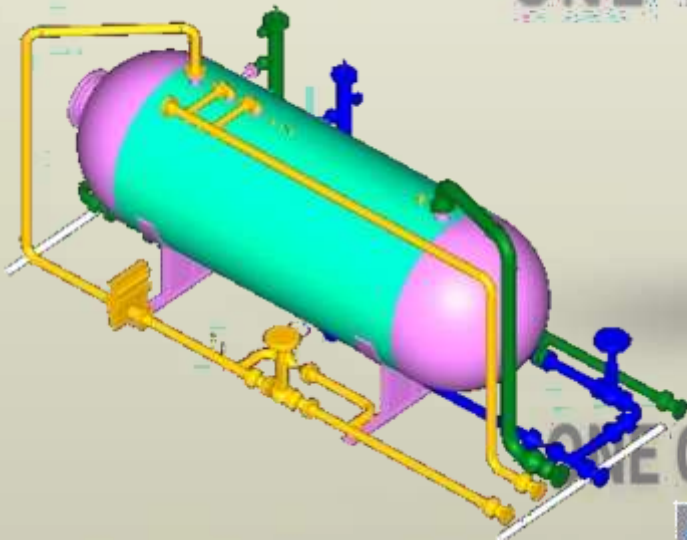

AUTODESK
AUTOCAD PLANT 3D

AUTODESK
FUSION 360



MAXXY GROUP
ONE GUYANA

ENGINEERING & DESIGN

We design and run engineering analysis over technological tools such as Autocad, constantly solving engineering problems and improving user experience



MAXXY GROUP



ONE GUYANA

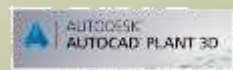

WHERE WE ARE LOCATED



MAXXY GROUP
ONE GUYANA



MAXXY GROUP





MAXXY GROUP
ONE GUYANA

Our Core Values

- **Safety.**
- **Quality.**
- **Customer satisfaction.**
- **Just-in-time project**

VALUE PROPOSITION

“Every day, we work dynamically to sustainably find the best solutions for our clients' needs.”

Rely on *MAXXY GROUP INC* as a strategic partner to help develop quality projects in the contract areas of influence or wherever required. Implement a monitoring, control, and improvement plan for assigned projects. Maintain an optimal inventory of supplies according to the contract's operational needs. Implement a value-based continuous improvement program. Effectively and efficiently provide personnel, resources, machinery, and equipment according to your needs.





MAXXY GROUP
ONE GUYANA

Sectors We Serve



**Building
Maintenance**



**Solar
Energy
Systems**



**Instrumentation
Engineering**



**Mechanical
Engineering**



**Electrical
Engineering**



**Power
Stations**



Oil and Gas

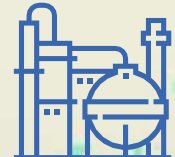

Refineries



Civil Works



**Marine
Maintenance**



**HVA
Engineering**



Comisioning

VALUE PROPOSITION



Below we list the different reasons we offer our clients and want to make available to you in our range of products and services, generating value for your company and your processes:

Every day, we work dynamically to sustainably find the best solutions for our clients' needs."

Rely on **MAXXY GROUP INC** as a strategic partner to help develop quality projects in the contract areas of influence or wherever required. Implement a monitoring, control, and improvement plan for assigned projects. Maintain an optimal inventory of supplies according to the contract's operational needs. Implement a value-based continuous improvement program. Effectively and efficiently provide personnel, resources, machinery, and equipment according to your needs.





SAFETY, HEALTH AT WORK AND ENVIRONMENT POLICY

MAXXY GROUP INC. is a company dedicated to the construction of civil works, metalworking assembly, specialized welding, architecture, and technical consulting. Therefore, it is committed, through all its employees, to complying with this comprehensive policy.

To this end, senior management undertakes the following:

- Provide the human, technical, and physical resources necessary for the implementation of the integrated management system.
- Continuously improve service quality, thereby increasing customer and stakeholder satisfaction, as well as performance in occupational health, safety, and environmental management.
- Develop programs to promote the quality of life of its employees, prevent occupational accidents and illnesses, and damage to property, while controlling the socio-environmental impacts inherent to the performance of its activities.
- Carry out its work with a commitment to continuous improvement through the identification, evaluation, and assessment of risks and the establishment of the respective controls, seeking the integrity of its employees, contractors, and all persons involved in the provision of its services.
- Commits to comply with applicable legal, national, local, and any other requirements subscribed to by the company regarding safety, occupational health, and the environment.

This policy will be implemented and communicated at all levels of the organization and is available to all interested parties. Signed, updated, and published in Georgetown, Guyana, on the 18th day of July 2025.

OUR SERVICES



We offer distinctive products and services, innovating and staying ahead of the curve to give our customers the best.

We are known for providing comprehensive support and solutions to their diverse needs.

Selection and application of industrial coatings.

Pipeline integrity management for the transportation of gas and hydrocarbons.

Inspection and quality testing, and non-destructive testing (NDT).

Design, manufacturing, assembly, and maintenance of structures and facilities in industrial plants.

Design, manufacturing, assembly, and maintenance of metal structures.

Maintenance and assembly of civil and electrical works. Project management. Personnel supply.

Our services include Piping, Civil and Structural Works, Electrical and mechanical Instrumentation & Installation, Stainless , Carbon Steel, Low Alloys Tank Fabrication, Shop Piping Fabrication, NDT , PWHT, Pre-commissioning, Commissioning & Star Up, Production Line Installation, Fire Suppression System, Food Production process and design , Water Treatment and water Treatment plant Installations.

We Offer Insulation Service for Buildings, Process Equipment, Or a Any Other Location where minimizing the Loss or Gain of Heat is Desired.

Thermal Insulation Contractors Install a Physical Barrier Material with a Low Thermal Conductivity to Reduce Heat Transfer Between Two Spaces.

Properly Insulating Buildings and Equipment Can Result in Energy Savings and Improved Process Efficiency.



MAXXY GROUP
ONE GUYANA

PIPESPECIALISTS

MAXXY GROUP INC has a team of pipe fitters with years of experience providing stainless steel process piping, mild steel pipe, PVC and HDPE pipe projects for various industries, from power generation, food production, chemicals, oil, gas and other industries.



ONE GUYANA





MAXXY GROUP
ONE GUYANA

SPECIAL WELDING

MAXXY GROUP INC HAS A PORTFOLIO OF CERTIFIED WELDERS TO PERFORM ALL TYPES OF SPECIAL WELDING WORK IN CHROME, MONEL, STAINLESS STEEL, CARBON STEEL.



MAXXY

GROUP

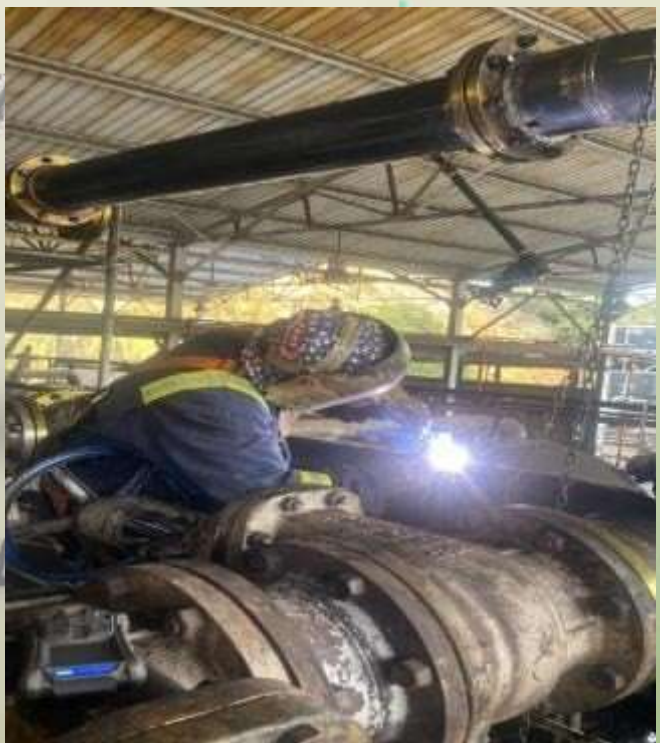

MAXXY GROUP IN. Guyana Company Profile

OUR WELDING STANDARDS



MAXXY GROUP
ONE GUYANA

Our welding standards are set to match international standards and not just any shabby work is acceptable.

We pride ourselves in our ability to hold our standards high.

SPECIAL WELDING IN CHROMIUM, MONEL, STAINLESS STEEL, CARBON STEEL



MAXXY

GROUP

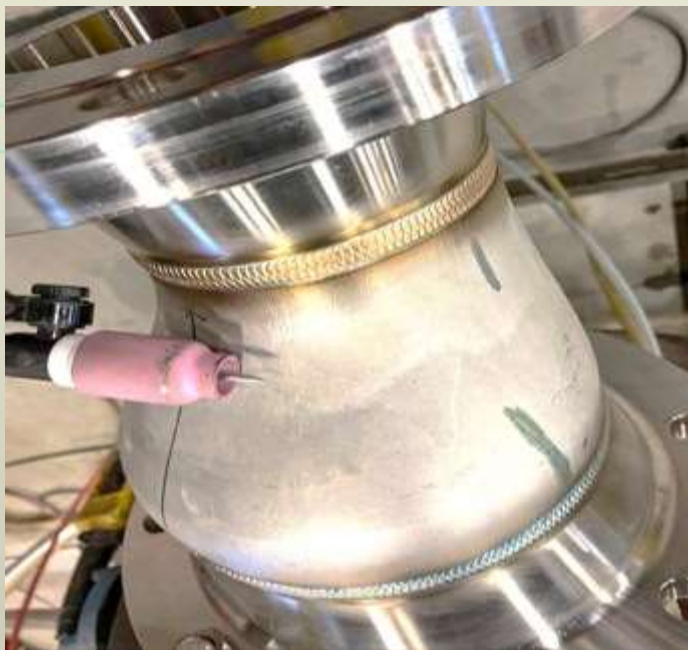

FIELD SERVICES FOR GAS, STEAM, AND GENERATOR TURBINES



MAXXY GROUP INC. HAS CERTIFIED PERSONNEL TRAINED TO PROVIDE ASSEMBLY SERVICES FOR TURBOGENERATORS, MAIN EQUIPMENT, AS WELL AS BALANCE OF PLANT. OUR SCOPE OF PROVISION RANGES FROM PLANNING TO START-UP. WE ADDITIONALLY HAVE AUXILIARY EQUIPMENT FOR TESTING INSTRUMENTS, CALIBRATING PROTECTIONS, ALIGNMENT AND BALANCING EQUIPMENT, AND PERFORMING BOROSCOPY.

MAXXY GROUP



COMBINED CYCLE

FIELD SERVICES FOR GAS, STEAM, AND GENERATOR TURBINES



MAXXY GROUP INC. SERVICES ALL TYPES OF GAS AND STEAM TURBINES AND AUXILIARY EQUIPMENT THROUGHOUT THEIR ENTIRE LIFE CYCLE, FROM OLDER TO LATEST-GENERATION EQUIPMENT (CI, HGPI, MI).

MAXXY GROUP INC. HAS CERTIFIED STAFF WITH INTERNATIONAL EXPERIENCE, AMONG OTHERS, IN:

GE: MS 5001B / 6001B / 6FA / 7FA

SIEMENS: 501F / W501D

TV: GE / MITSUBISHI / SKODA / ALSTOM / TGM

HYUNDAI ENGINEERING / 160MW COAL-FIRED GENERATION



MAXXY GROUP INC. Guyana Company Profile

MAXXY GROUP INC. Guyana Company Profile

MAXXYGROUP.COM

SPECIALISTS IN TANK CONSTRUCTION



MAXXY GROUP
ONE GUYANA

At **MAXXY GROUP INC**, we perform engineering analysis using cutting-edge technological tools to build different tank models for various industries.



MAXXY GROUP



GU



ONE GUYANA



MAXXY GROUP
ONE GUYANA

SCAFFOLDING MATERIAL

***MAXXY GROUP INC OFFERS ITS
RING LOCK SFORCEMENT AND
DISASSEMBLY SERVICES, WITH
CERTIFIED PERSONNEL***





MAXXY GROUP
ONE GUYANA

OFFSHORE WORKS

MAXXY GROUP INC OFFERS ITS SERVICES, EXPERIENCE, AND SPECIALIZED PERSONNEL IN OFFSHORE OIL PLATFORMS



MAXXY GROUP





MAXXY GROUP
ONE GUYANA

OFFSHORE WORKS

MAXXY GROUP INC OFFERS ITS SERVICES, EXPERIENCE, AND SPECIALIZED PERSONNEL IN OFFSHORE OIL PLATFORMS, MECHANICAL MAINTENANCE



ONE GUYANA





MAXXY GROUP
ONE GUYANA

ELECTRICAL INSTALLATION & INSTRUMENTATION

Our team of qualified electricians provide a vast scope of services ranging from electrical powering and lighting, Automation of equipment, repairs and installation work.



ONE GUYANA





MAXXY GROUP
ONE GUYANA

MECHANICAL INSTALLATIONS

Our team have vast experience in installation of process equipment, tanks, mechanical and electrical assemblies. We install to precision of both small, medium and large assemblies using appropriate equipment such as Cranes.



ONE GUYANA



PRODUCTION LINE INSTALL



MAXXY GROUP
ONE GUYANA

We install production line equipment for various produce such as fruit and juice, wine, alcoholic and non-alcoholic, food, grain processing, soap, biscuit and a host of other produce.



ONE GUYANA



STRUCTURAL FABRICATION



MAXXY GROUP
ONE GUYANA

Our structural and Civil team provide AutoCAD, structural design analysis and all other detailed engineering for your projects.



ONE GUYANA



FIRE FIGHTING SYSTEM



MAXXY GROUP
ONE GUYANA

Installing Fire fighting system a & Water Extinguishing Systems (sprinkler and deluge), Foam Fire Extinguishing Systems, Clean Gas Extinguishing Systems, CO2 Gas Fire Extinguishing Systems



MAXXY GROUP

FIRE DETECTION AND EXTINGUISHING SYSTEM

ONE GUYANA





MAXXY GROUP
ONE GUYANA

WATER TREATMENT PLANT INSTALL

We offer a range of service in water production and treatment from source (river, underground sourcing) to pre treatment, filtration, reverse osmosis, UV lighting and ozonation.

We provide high quality welding seams that prevents contamination by medium and ensures proper cleaning.



GUYANA





MAXXY GROUP
ONE GUYANA

HVAC INSTALLATION

We design a wide array of HVAC systems for domestic, commercial and industrial purposes from your homes to your companies. This demonstrates our expertise in understanding different spaces and coming up with a ventilation plan for each unique space.

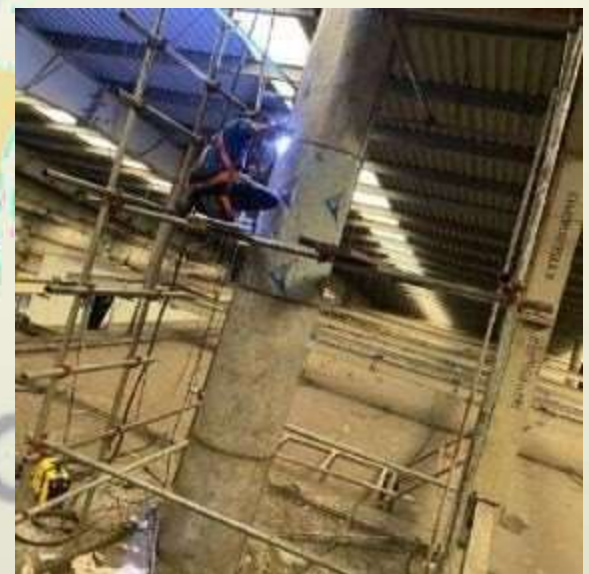

ONE GUYANA



UYAN



MAXXY GROUP
ONE GUYANA

Diesel and Electromechanical Service for Heavy Machinery

MAXXY GROUP INC have certified and trained personnel to coordinate a comprehensive preventive, predictive, and corrective maintenance plan for excavators, wheel loaders, skid steer loaders, bulldozers, backhoe loaders, telehandlers, vibrocompactors, motor graders, and more.

MAXXY GROUP INC have extensive experience in Construction and Mining Support Equipment, such as motor graders and Ingersoll Rand, Volvo, Hamm, and Dynapac vibratory compactors, as well as backhoe loaders from Caterpillar, Volvo, Hyundai, Ingersoll Rand, JLG, Kobelco, Hyundai, Terex, Grove, Link Belt, and more.

MAXXY GROUP





MAXXY GROUP
ONE GUYANA

PROCUREMENT

Our service is structured to help individuals, businesses and organizations maximize their investments by providing an impeccable value and reliable service. PPI Limited will work closely with you and your team to identify and manage costs across all purchase categories and procurement chain. Through our supply chain network and partnerships with OEM (Original Equipment Manufacturers), you can rely on us to deliver the absolute quality.

MAXXY GROUP INC HAVE ALLIES IN DIFFERENT PORTS IN NORTH AMERICA, CENTRAL AMERICA AND THE CARIBBEAN, CUSTOMS AGENTS, CARGO SHIP FLEET



QHSE POLICY STATEMENT



MAXXY GROUP
ONE GUYANA

- **MAXXY GROUP INC. goal is to provide a safe and healthy work environment that is free from workplace injury and illness. This will only be achieved through the participation, co-operation and commitment of everyone in the workplace.**
- **Our priorities are;**
 - **A key Objective is Zero incidents throughout the organization and protect the environment.**
 - **Minimizing environmental impacts associated with its activities.**
 - **Comply with all legal and other requirements.**
- **The following principles must be applied every day and at all sites in order to succeed in our commitment:**
 - **Remove or alleviate hazardous situations in order to minimize risks to personnel**
 - **Set HSE performance objectives, measure results, assess and continually improve processes, through the use of an effective management system**
 - **Guarantee and monitor that our activities have minimal impact on the environment.**
 - **Minimize our impact on the environment through pollution prevention, reduction of natural resource consumption and emissions, and the reduction and recycling of waste**
 - **Apply our technical skills to all Health, Safety and Environment aspects in the design and engineering of our services and products**
 - **Report and analyze all accidents, incidents and anomalies.**
 - **Monitor our performance and check our management system in order to improve rules and procedures in conducting our activities.**
 - **Maintain a consistent and transparent dialogue with authorities, local realities and other stakeholders, openly communicating our HSE policies, standards, programs and performance.**

OUR PERSONAL

- We recruit well educated and ambitious people who thrive on change and challenge, are innovative, self-confident and accept responsibility by taking initiative and adapting to a stimulating working environment. We seek leadership traits, excellent communicators, strong academic performance and relevant professional experience.
- People are the most important capital for our company. We recruit the very best and also grow our own talent. In all our offices and facilities, you will find outstanding individuals working to high standards as part of a powerful team.

At *MAXXY GROUP INC*, we have a competent, committed, and highly experienced team that meets the demands of our clients. We are characterized by having specialists in different areas of work, and we also develop them to create a highly competent team. Our engineers, specialists, supervisors, and technicians are constantly training and adapting our security plans to meet our clients' demands.



OUR ORGANIGRAMA



MAXXY GROUP
ONE GUYANA

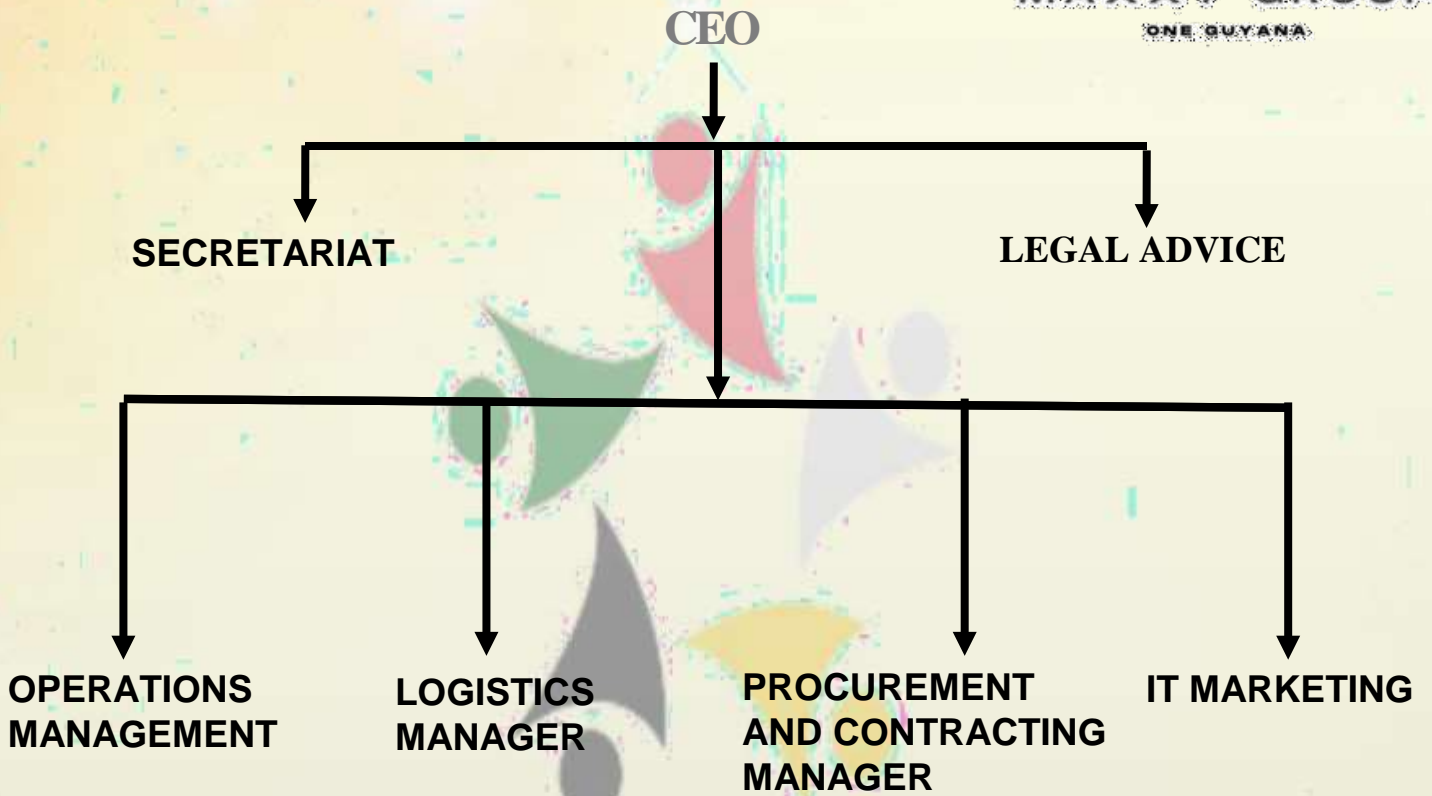

+ (592) 637-58.87
 info@maxxygroup.com
 www.maxxygroup.com
 Business Consulting - Strategic Planning - Project Management - Compliance and Regulatory Advisory - Market Research and Analysis - Training and Capacity Building - Partnership Facilitation
 @maxxygroup

MAXXY GROUP
ONE GUYANA
Brayan De Freitas
CEO

+ (57)300-5144102
 yoer.arenas@maxxygroup.com
 www.maxxygroup.com
 Business Consulting - Strategic Planning - Project Management - Compliance and Regulatory Advisory - Market Research and Analysis - Training and Capacity Building - Partnership Facilitation
 @maxxygroup

MAXXY GROUP
ONE GUYANA
Yoer Arenas
Operations Manager

+ (507)6939-0621
 carlos.oliveros@maxxygroup.com
 www.maxxygroup.com
 Business Consulting - Strategic Planning - Project Management - Compliance and Regulatory Advisory - Market Research and Analysis - Training and Capacity Building - Partnership Facilitation
 @maxxygroup

MAXXY GROUP
ONE GUYANA
Carlos Oliveros
Procurement and Contracting Manager

+ (592)718-0809
 allen.lira@maxxygroup.com
 www.maxxygroup.com
 Business Consulting - Strategic Planning - Project Management - Compliance and Regulatory Advisory - Market Research and Analysis - Training and Capacity Building - Partnership Facilitation
 @maxxygroup

MAXXY GROUP
ONE GUYANA
Allen Lira
Logistics Manager

Profile

Contact Us

Office Address

Lot # 15. Agricola.
Main Road Demarara.
Georgetown - Guyana

Phone Number

+592 6375887 | +592
7180809

Email Address

info@maxxygroup.com



ONE GUYANA

MAXXY GROUP INC.

MAXXY GROUP IN. Guyana Company Profile



MAXXY GROUP
ONE GUYANA